

单孔固定面盆龙头

安装说明书

Single Mount Lavatory Faucet

INSTALLATION INSTRUCTIONS

如需安装支持，配件丢失等，请联系MOEN。
对于中国大陆以外的市场，请咨询当地经销商。

(中国大陆) 400-630-8866

(中国大陆) www.moen.cn

(中国大陆以外) www.moen.com.hk

PLEASE CONTACT MOEN FIRST

For Installation Help, Missing or Replacement
Parts. For markets exclude Chinese mainland,
please consult your local dealer.

(Chinese Mainland) 400-630-8866

(Chinese Mainland) www.moen.cn

(Exclude Chinese Mainland) www.moen.com.hk

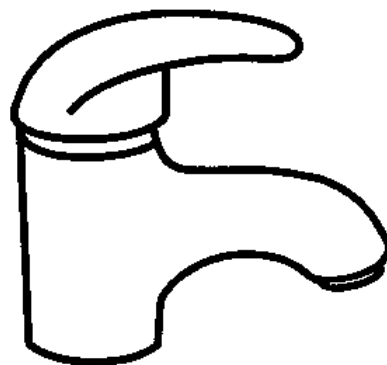

图片仅供参考

(款式因型号而异)

Image is for reference only
(Style varies by model)

记录购买的型号：

(保存安装说明书以备将来参考)

Record Purchased Model Number:
(Save instruction sheet for future reference)

推荐工具

为了安全和让安装和替换变得容易，Moen建议您使用以下工具：

HELPFUL TOOLS

For safety and ease of replacement, Moen recommends the use of these helpful tools.



温馨提示/Installation & Maintenance

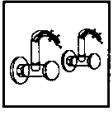

1. 产品安装前，请务必打开冷热供水，先将供水管内积累的杂质冲洗干净，以免损坏龙头。
Prior to installing new faucet, flush supply lines to remove any accumulated debris.
Accumulated debris can damage new faucet.



2. 本产品建议由有经验和有资质的专业人员进行安装，以免安装质量问题造成不必要的损失。
Faucets should be installed by a qualified & experienced person to ensure proper installation.



3. 本产品必须在在安全供水压力下(公称压力不大于1.0MPa) 进行使用。确保龙头良好使用，请保持冷热水的供水压力平衡。
Water supply pressure should not exceed 1.0 MPa. For best faucet performance, hot & cold supply pressures should be approximately equal.

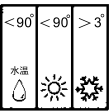

4. 本产品适用于建筑物内冷热供水管路上，介质温度不大于90摄氏度;不能在除水以外的其它流体环境中使用或者其它用途；请注意因为产品使用环境温度过低(低于3℃)或者环境温度过高(高于90℃)而造成产品或者零件损坏
Faucet is for indoor use only. Hot water supply temperature should not exceed 90°C, To avoid damaging faucet, the ambient temperature at the site of installation should be greater than 3°C and less than 90°C.

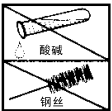

5. 本产品表面不能用钢丝球等坚硬材质擦洗，以免损坏表面镀层，建议使用柔软材质进行清洗;本产品不能用酸、碱等物质清洗，建议使用中性清洁剂进行清洗。
Clean faucet with only water and a soft cloth. Do not use abrasive cleaning pads or harsh/abrasive chemicals, these will damage faucet finish.

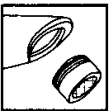

6. 在同等压力下，如果发现水流量减小，请及时清理产品水嘴口部的过滤网。
If water flow decreases over time, remove aerator & rinse out accumulated debris

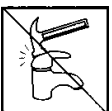

7. 请根据使用说明轻开轻关使用产品；请不要用外力推压、摇晃龙头，以免损坏龙头。
Use faucet only as directed in instruction manual, do not abuse or misuse faucet.

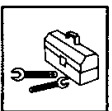

8. 产品如果配备专用工具，请妥善保管，以备日后维修保养使用。
Keep instruction manual and any special tools provided for maintenance & future reference.

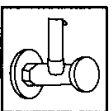

9. 在更换或者拆卸龙头前，务必先关断水源，然后打开龙头，释放供水管内压力，并检查水路，确保水源完全关断。
Always turn water supply OFF before removing existing faucet or disassembling the valve.
Open faucet handle to ensure complete water shut-off has been accomplished.



10. 如果长时间外出，请事先关闭水龙头角阀，打开水龙头开关释放龙头中的压力和积水。
If faucet will not be used for a long period of time, shut off water supply to faucet. Open faucet handle to release pressure.

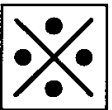

- 摩恩公司保留对产品进行修改、改进的权利；技术参数如有改变，恕不另行通知。
MOEN reserves the right to modify or improve our products, Products shall be subject to any changes without additional notice.

产品安装步骤

Installation Instructions

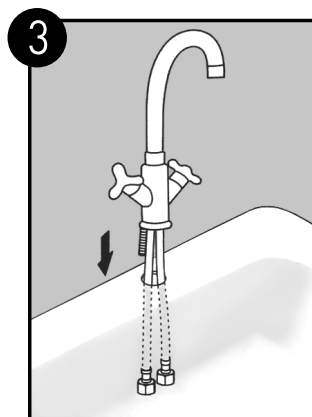
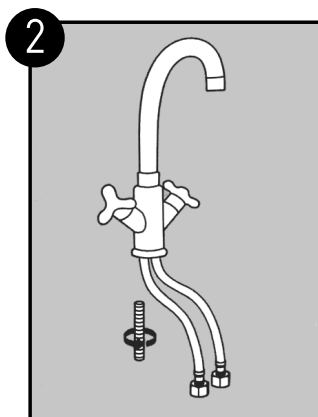

产品有单杆固定或双杆固定
Product may have either one or two mounting studs

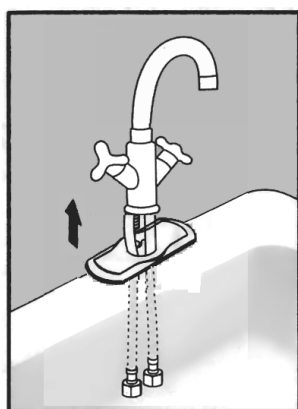

有盖板的产品，请先安装盖板
Escutcheon may be included

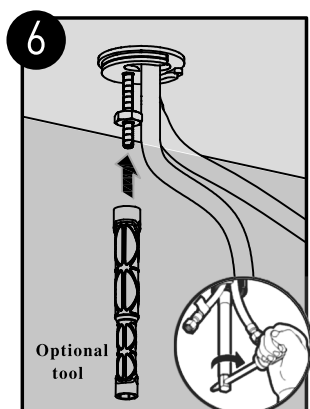
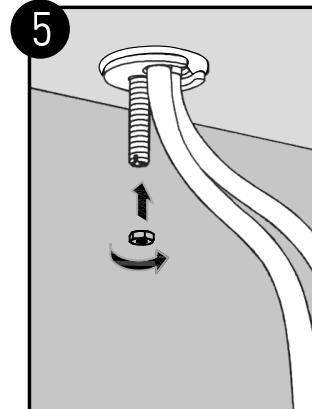
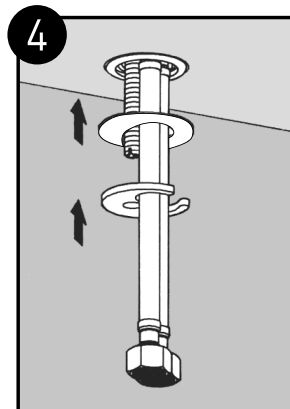

用扳手或选配工具锁紧螺母
Use wrench or optional tool to tighten the nut

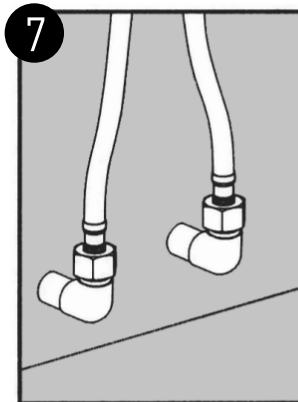

请确保冷热水管连接满足冷热水控制要求
Check that hot & cold supply hoses are connected correctly to hot & cold water supplies



如有落水组件，请看步骤⑧或参考其包装上的安装说明
If with waste assembly, please go to ⑧ or refer to the installation in the package

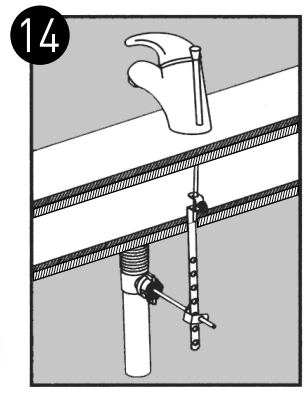
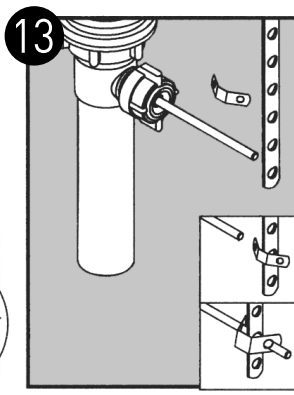
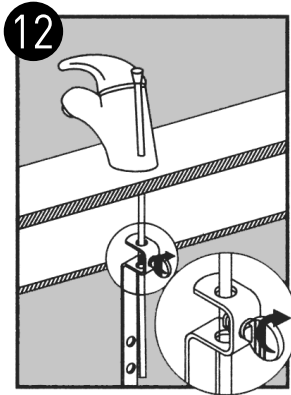
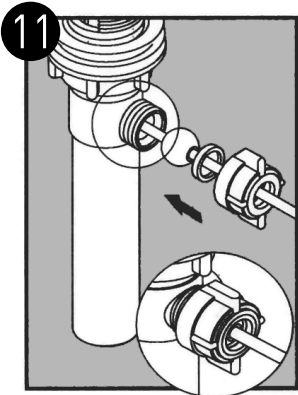
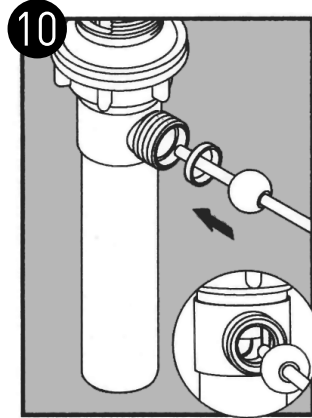
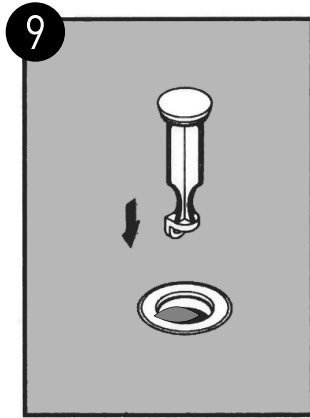
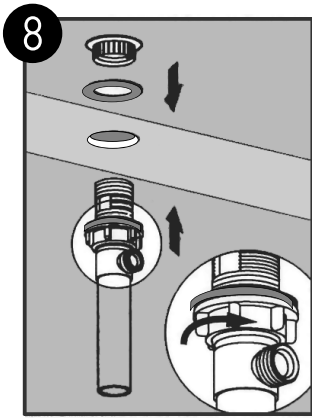

产品使用说明 Operation Instructions

单把手产品/One handle

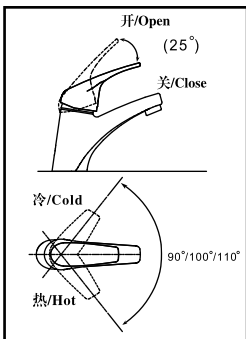

双把手手轮产品/
Product with hand wheel

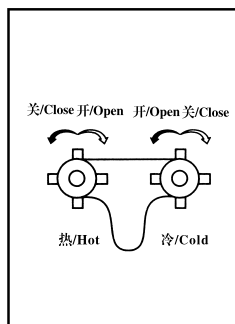

双把手手柄产品/
Product with hand lever

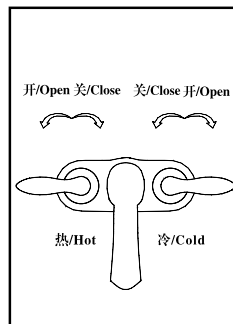

产品售后保修条款

摩恩产品是在高质量标准及生产工艺下制造的，摩恩承诺为消费者购买的洁具产品提供有期限免费保修及终身维修服务。

龙头免费保修期为：阀芯5年，电磁阀感应器2年，其它附件如淋雨杆、软管、花洒、落水、把手、装饰盖、提拉杆、混水器等保修期均为1年有限。均自消费者购买日（以摩恩产品分销商开具的发票或收据上载明日期为准）起计。

免费保修范围为产品及产品配件（如淋雨杆、软管、花洒、落水、把手、装饰盖、提拉杆、混水器等）由于材质及工艺原因而造成的故障或损坏。免费保修期内，我们将无偿为您提供维修服务及更换发生故障的产品或产品配件。摩恩的售后服务责任仅限于对故障产品的修理，而不延及您因产品故障而发生的其他损失，法律另有规定的除外。

您需了解：产品外观碰伤、刻划痕迹，以及滥用及不正当保养所导致的故障或损坏，均不属于免费保修范围。即使在免费保修期内，属下列（1）-（5）情况之一的，需酌情收取修理费用：

1. 不能出示相符的保修卡和有效购买凭证情况的，
2. 未按使用说明告知的使用方法和注意事项造成的故障，
3. 自行拆卸、维修、改装所造成的故障和损坏，
4. 由于不可抗力等外部原因引起的故障和损坏，
5. 由于运输、搬运、挤压等造成的损坏。

对于保修期外或不在保修范围内的产品，如需维修，摩恩将酌情收取上门费、人工费及材料费。

本保修条款仅对原始消费者和酒店行业的购买者有效，并不适用于本产品工业、商业、贸易和非酒店行业的使用。

如对本保修条款内容有任何疑问，请拨打400 630 8866 咨询热线，或向当地分销商咨询。对于中国大陆以外的市场，此产品的保修及保障服务详情请咨询当地经销商。

摩恩公司对摩恩保修拥有最终解释权。

MOEN LIMITED WARRANTY

We offer limited warranty and lifetime maintenance for Moen products, which are all manufactured with high standards of workmanship.

The period of warranty shall start from the date of purchase of the product (according to the invoice or receipt issued by Moen distributors) and shall cover a period of the following: the warranty period for cartridge is 5 years, the warranty period for solenoid valve sensor is 2 years, the warranty period of other accessories such as shower bar, hose, shower, drain assembly, handle, cover, lift rod, aerator etc. is 1 year.

This warranty is your coverage against material and workmanship malfunction or defects in Moen products or components (such as shower bar, hose, shower, drain assembly, handle, cover, lift rod, aerator etc.). During the warranty period, we offer free maintenance and changing of malfunctioned products or product components. Moen's after sales service liability is limited to the maintenance of faulty items and does not cover your other losses caused by product malfunction, except for otherwise stipulated by law.

Cosmetic damages (scratches, dents, etc.) and malfunction or defects caused by abuse or improper maintenance is not covered by this warranty.

Although the warranty period remains valid, in case of the following conditions (1) - (5), the maintenance cost (material cost and labor cost) shall still be charged as the case may be:

1. Corresponding warranty card and valid invoice cannot be presented;
2. Faults were caused by the incompliance with the instructions and precautions provided in the user's manual;
3. Damages and faults were caused by self-actuated dismantling, repair and refit;
4. Faults and damages were caused by external factors such as force majeure;
5. Damages were caused by transportation, unloading and extrusion, etc.

This warranty is valid for the original consumers only (including hotel use), and excludes industrial and commercial use of the product (except for hotel use). This card is only responsible for product maintenance rather than any other liabilities.

In the event that the product requires maintenance but exceeds the warranty period, or that the product is not covered by this warranty, labor cost and material cost shall be charged as the case maybe. Please call 400-630-8866 or contact local dealer for any question. For markets exclude Chinese mainland, the terms and conditions of warranty shall differ between product categories and countries. Please refer to warranty stated by local distribution. Moen Incorporated shall have the final interpretation of Moen warranties.

MOEN® 摩恩

合格证 Compliance Certification

产品名称
Product Name

单孔固定面盆龙头
Single Mount
Lavatory Faucet

检验员
Inspector

生产日期
Date of Production

富俊汇赢科技（上海）有限公司
中国（上海）自由贸易试验区新杨公路
1800弄1号4幢207室
邮编：201413

Fortune Brands Innovations (Shanghai) Co., Ltd
Room 207, Building 4, No. 1, Lane 1800, Xinyang Highway,
China (Shanghai) Pilot Free Trade Zone